

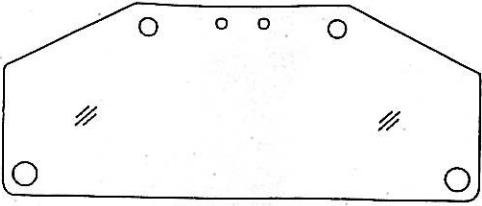

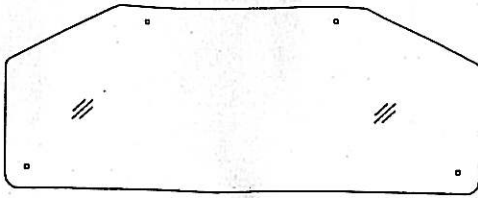

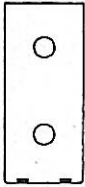

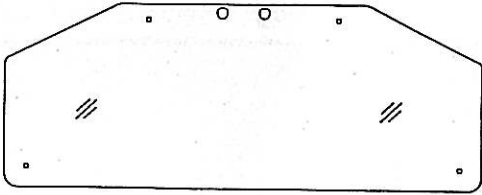

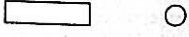

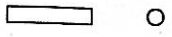

T-701

# ASSEMBLY INSTRUCTION

## PARTS LIST

<p>1. - 1 Pc.</p> 	<p>2. - 1 Pc.</p> 	<p>3. - 1 Pc.</p> 
<p>4. - 1 Pc.</p> 	<p>5. - Ø50- 4 Pcs.</p> 	<p>7. - Ø50- 2 Pcs.</p> 
	<p>6. - Ø38- 4 Pcs.</p> 	<p>8. - Ø38- 2 Pcs.</p> 

## FITTINGS

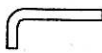
<p>A. -M8x20 - 4 Pcs.</p> 	<p>B. M8- 4 Pcs.</p> 	<p>C. - 8 Pcs.</p> 	<p>D. - 8 Pcs.</p> 	<p>E. -M8- 8 Pcs.</p> 
<p>F. -M8 - 4 Pcs.</p> 	<p>G. - 4 Pcs.</p> 	<p>H. -M8- 1 Pc.</p> 	<p>I. -M8- 8 Pcs.</p> 	<p>J. -M4- 1 Pc.</p> 

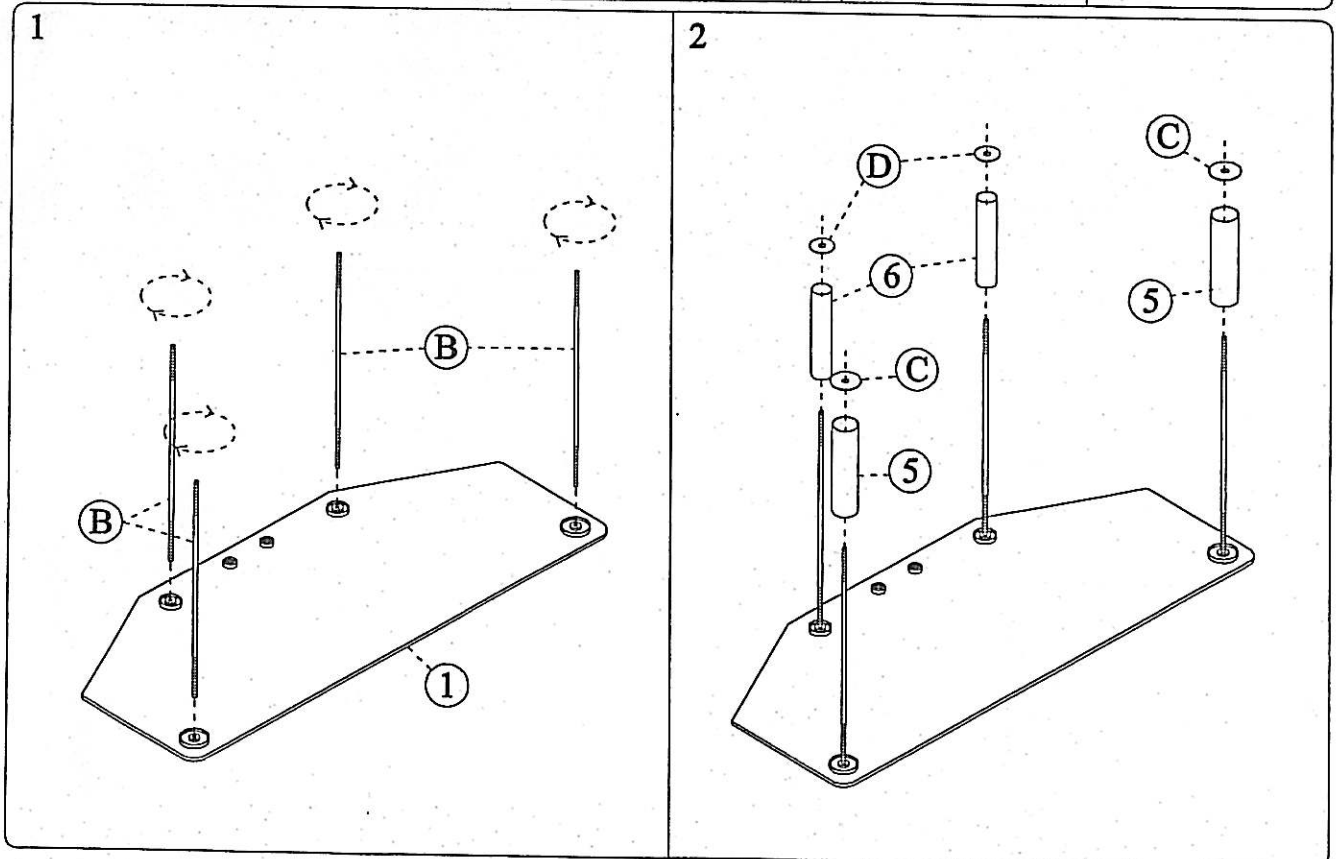

# ASSEMBLY INSTRUCTION

T-701

3

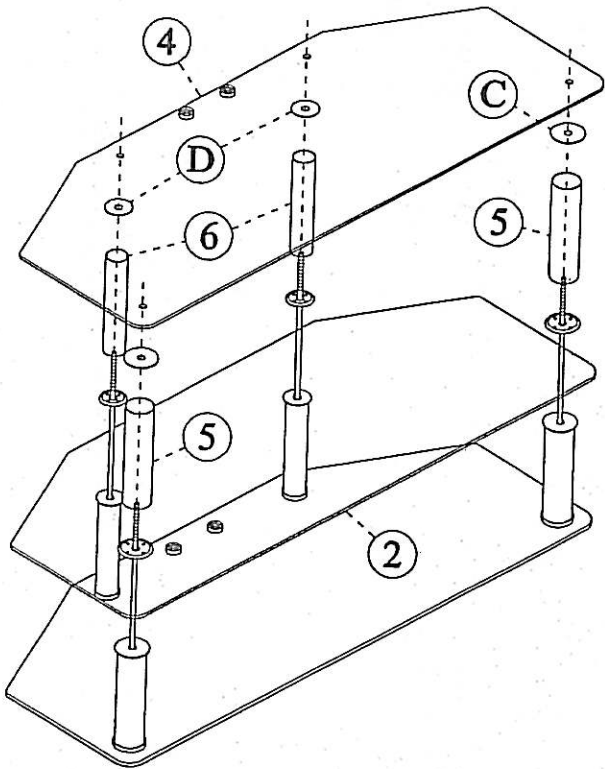

4

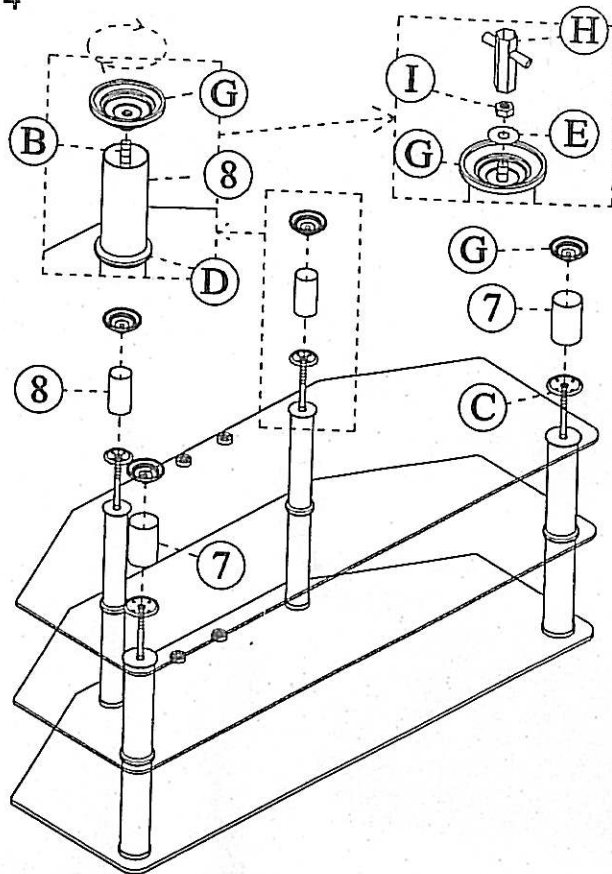

5

