

T-2300-S

ASSEMBLY INSTRUCTIONS

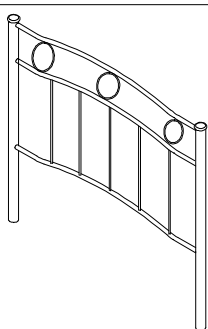

A*1PC

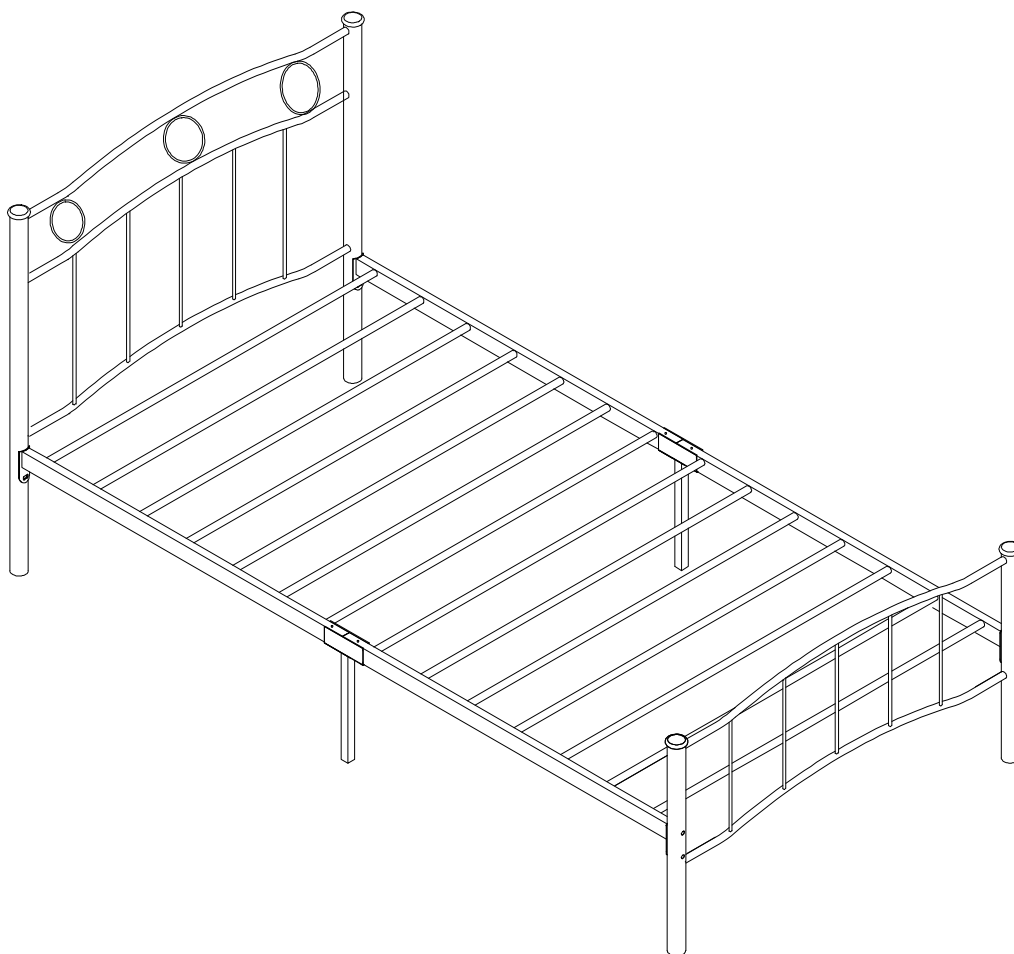
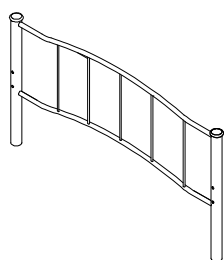

B*1PC

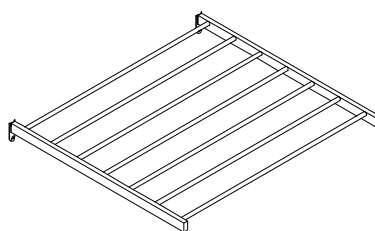

C*2PCS



D*2PCS

1/4"*47mm



E*8PCS

M8*50mm



F*4PCS

1/4"



G*4PCS

M8



H*4PCS

4M



I*1PC

5M



J*1PC

1/4"

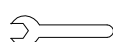

K*1PC

M8

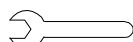

L*1PC

Note: Pls do not tighten all bolts until the bed is assembled completely

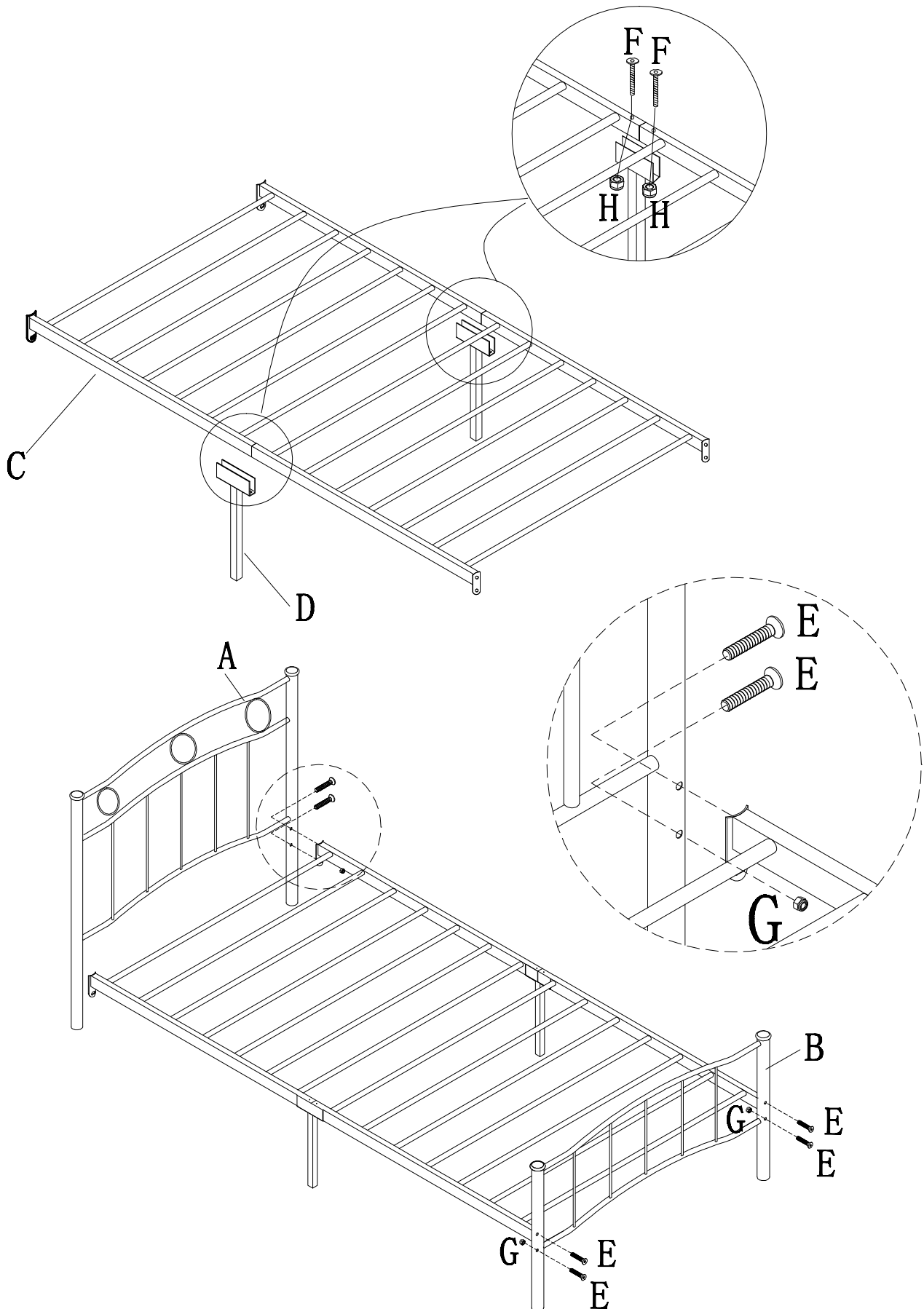

T-2300-D

ASSEMBLY INSTRUCTIONS

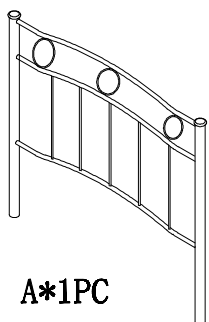
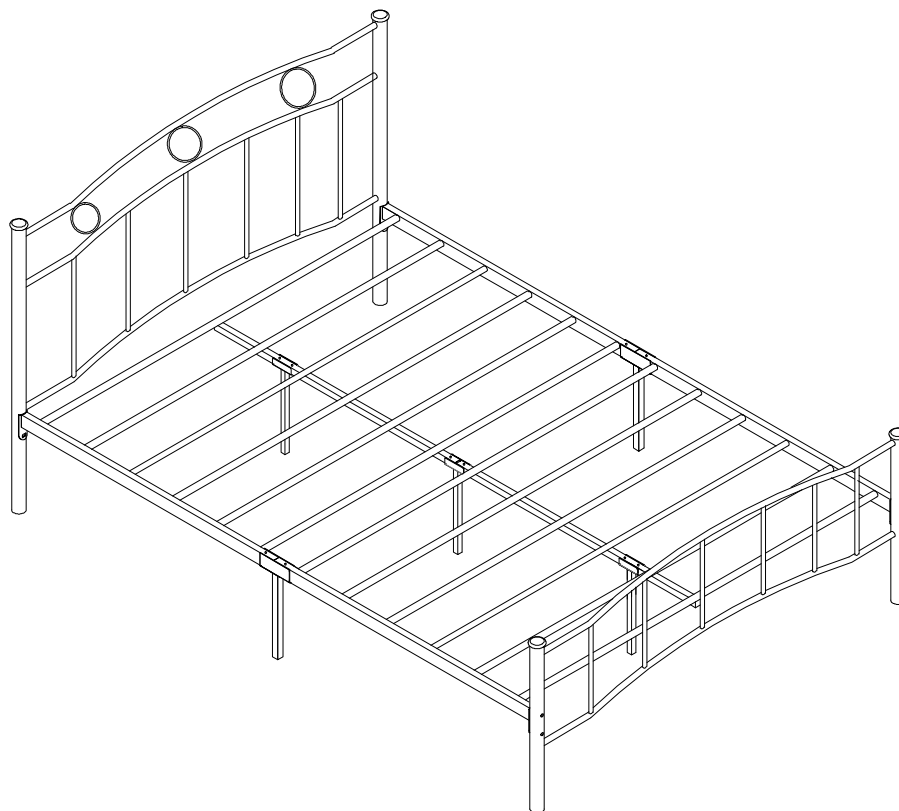

A*1PC

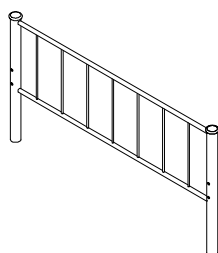

B*1PC

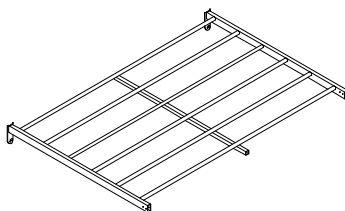

C*2PCS

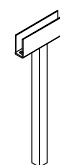

D*2PCS



E*3PCS

F*8PCS



1/4" * 47MM

G*4PCS



M8 * 50MM

H*6PCS



1/4" * 25MM

I*4PCS



1/4"

J*4PCS



M8

K*1PC



5M

L*1PC



4M

M*1PC

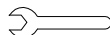

1/4"

N*1PC

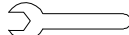

M8

Note: Pls do not tighten all bolts until the bed is assembled completely

