









MODEL : T-5069 3PCS COFFEE (EDDIE COFFEE) ASSEMBLY INSTRUCTION

Important note : - Place all wooden part on a clean and smooth surface such as rug or carpet to avoid the part from being scratch

- Please follow the assembly instruction step by step

- Do not tighten all screw until the table fully set-up

PARTS LIST		
NO	DESCRIPTION	QTY
A	TOP PANEL 	1
B	LEFT LEG PANEL 	2
C	RIGHT LEG PANEL 	2
D	SECOND LAYER 	1

HARDWARE LIST		
NO	DESCRIPTION	QTY
1	JCBC SCREW M6 X 35MM 	12 PCS
2	FLAT WASHER 	8 PCS
3	SPRING WASHER 	8 PCS
4	NAIL LEG 5/8" 	4 PCS
5	ALLEN KEY 	1 PC

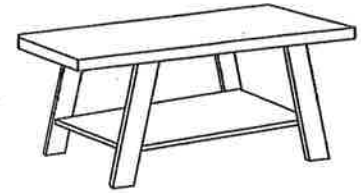

COMPLETED ASSEMBLE

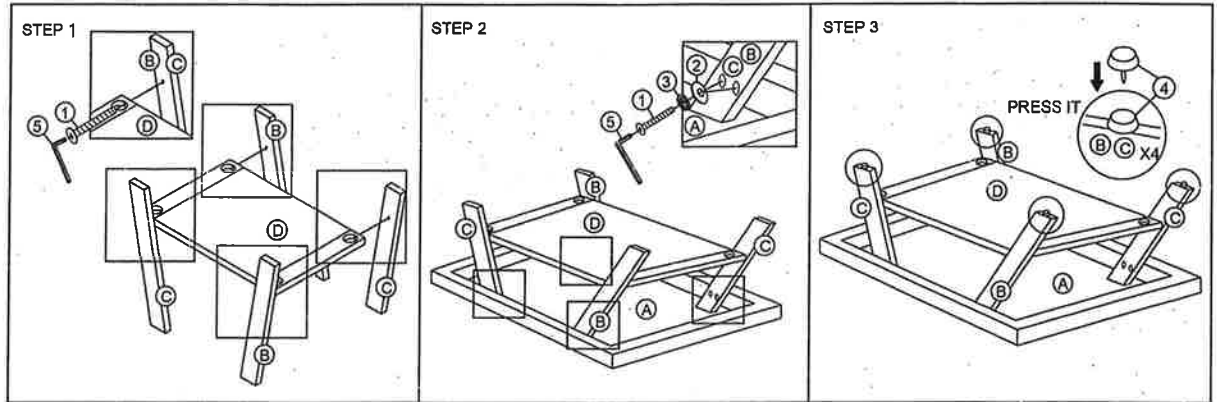









MODEL : T-5069 3PCS COFFEE (EDDIE END) ASSEMBLY INSTRUCTION

Important note : - Place all wooden part on a clean and smooth surface such as rug or carpet to avoid the part from being scratch

- Please follow the assembly instruction step by step

- Do not tighten all screw until the table fully set-up

PARTS LIST - 1PC		
NO	DESCRIPTION	QTY
A	TOP PANEL 	1
B	LEFT LEG PANEL 	2
C	RIGHT LEG PANEL 	2
D	SECOND LAYER 	1

HARDWARE LIST - 1PC		
NO	DESCRIPTION	QTY
1	JCBC SCREW M6 X 35MM 	12 PCS
2	FLAT WASHER 	8 PCS
3	SPRING WASHER 	8 PCS
4	NAIL LEG 5/8" 	4 PCS
5	ALLEN KEY 	1 PC



COMPLETED ASSEMBLE

