

ASSEMBLY INSTRUCTIONS

T2157

Height from floor to top of slats: 14"H

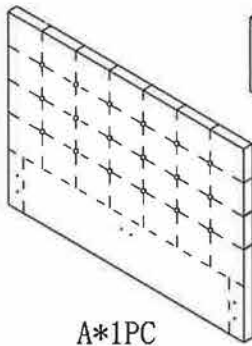
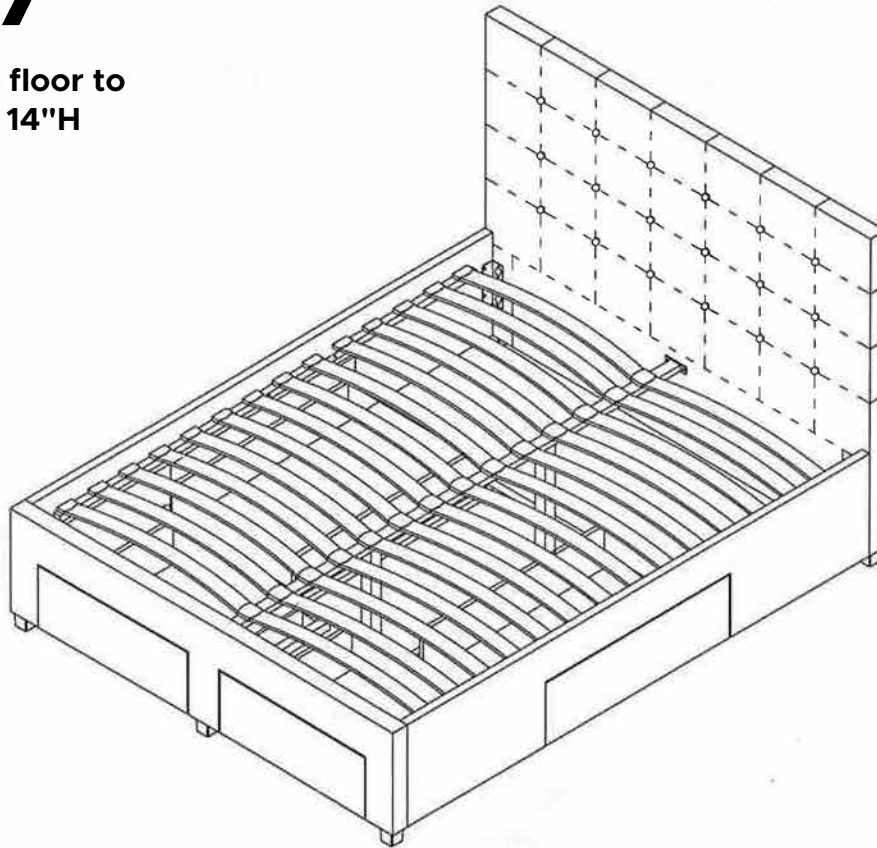

A*1PC

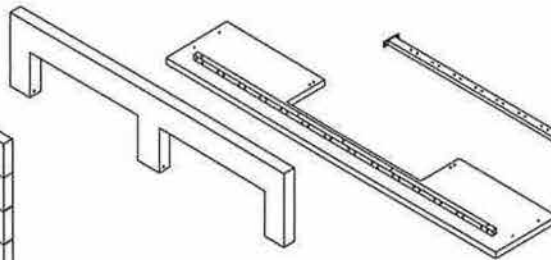

B*1PC

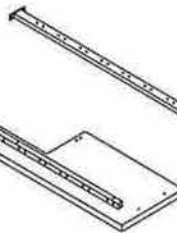

C*2PCS



D*1PC

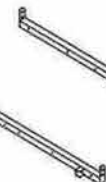

E1*1PC



E2*1PC



F*2PCS



G1*2PCS



G2*2PCS

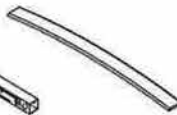

H*28PCS



I*5PCS



J1*2PCS



J2*4PCS



K*14PCS



L*28PCS



M*4PCS



M8*30MM



1/4"*16MM



1/4"*40MM

P*4PCS



Q*8PCS

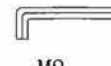

M8

R*1PC



1/4"

S*1PC



T*5PCS

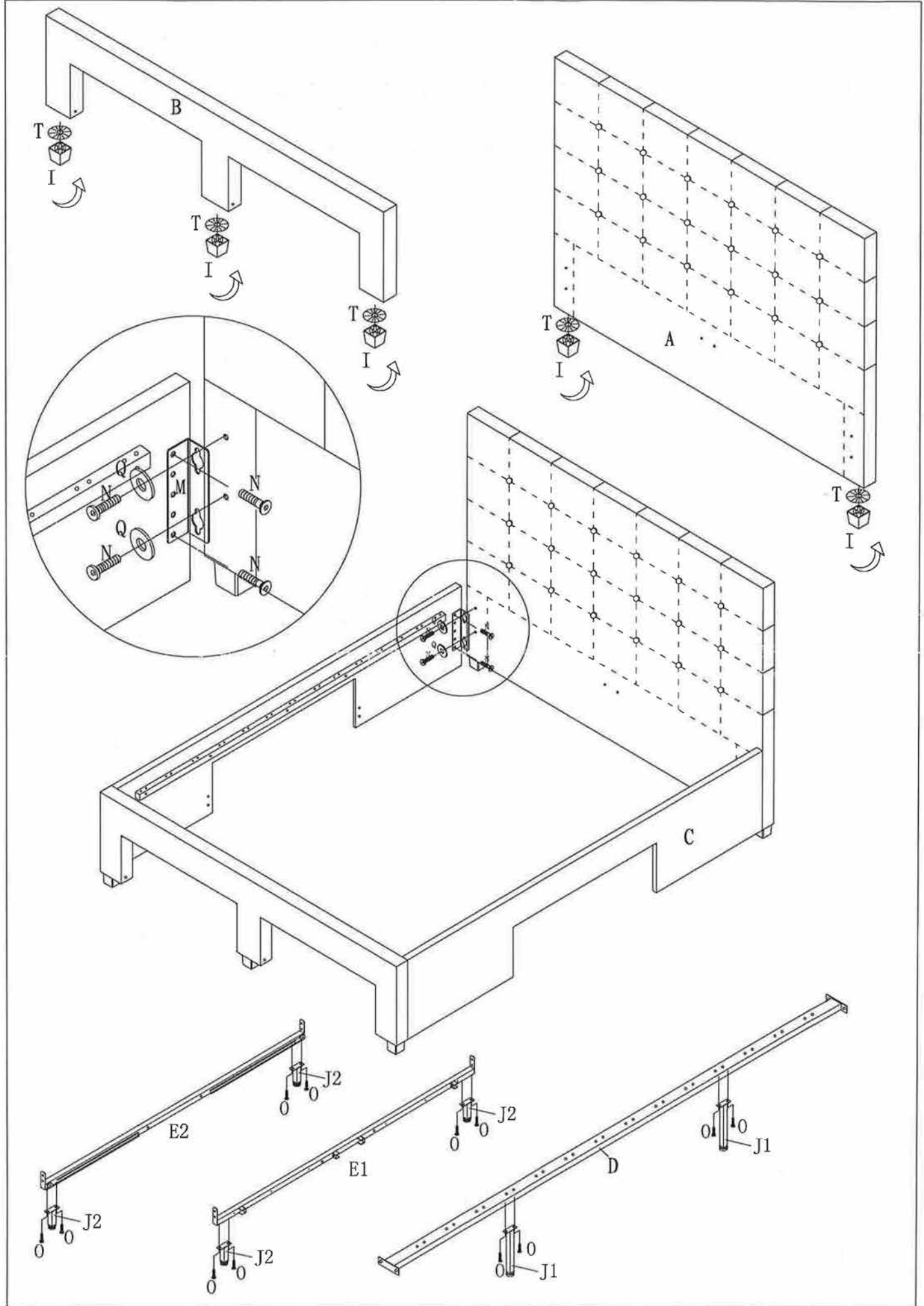

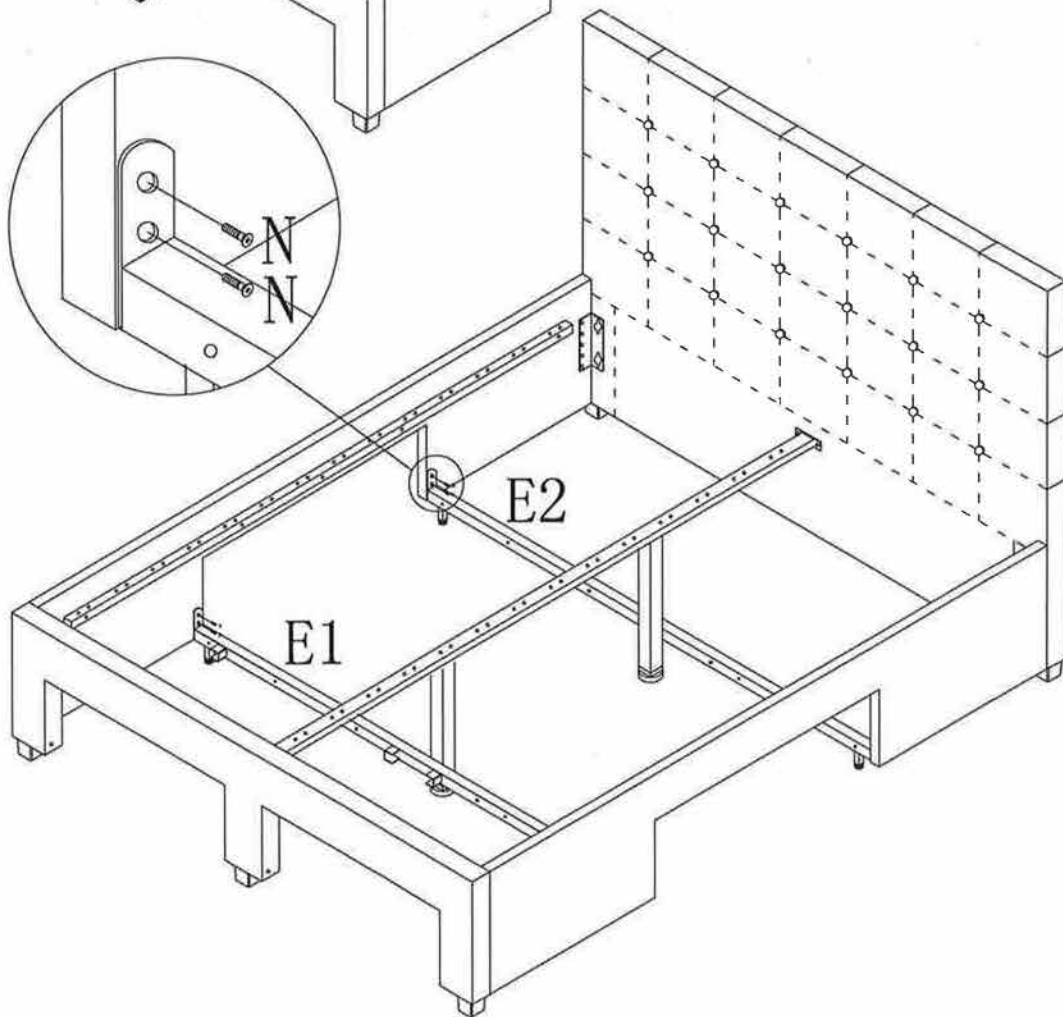
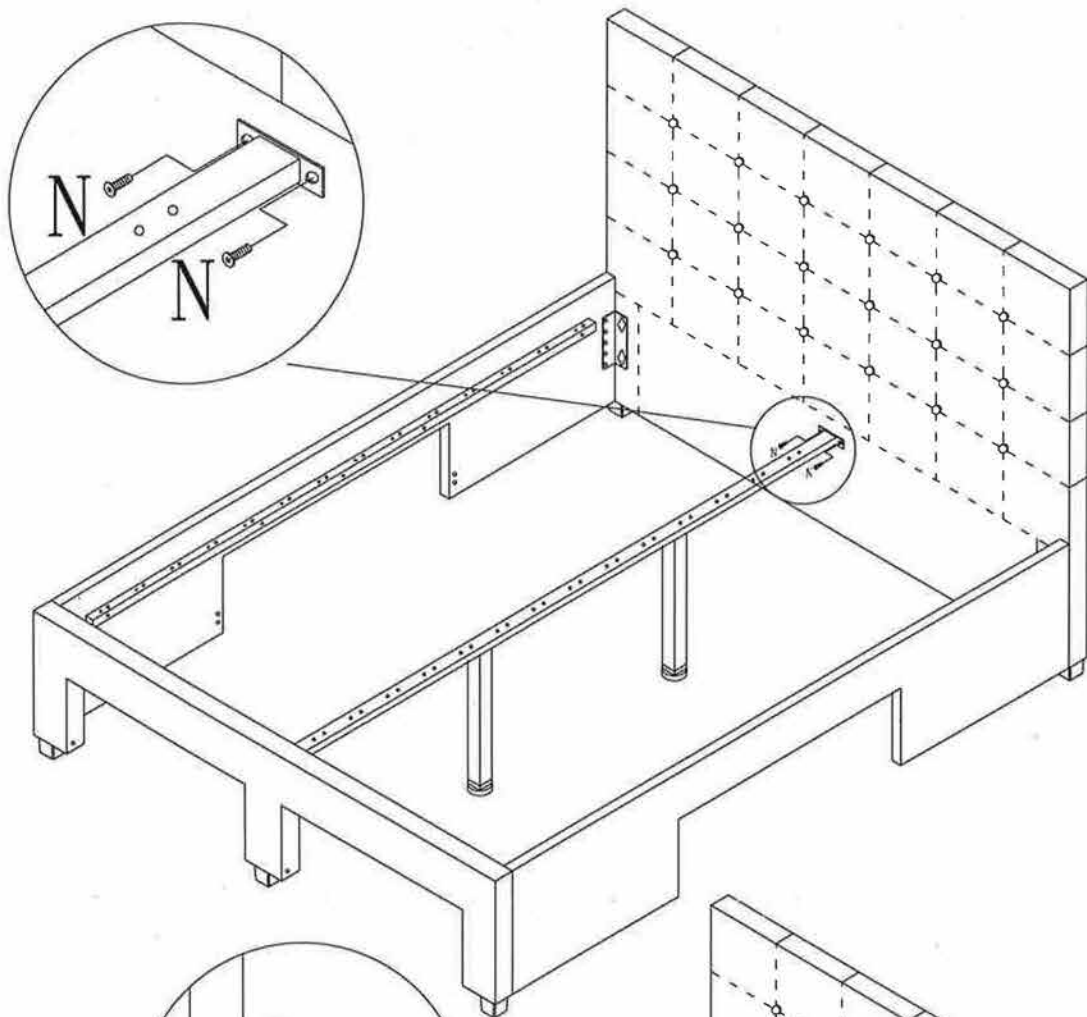

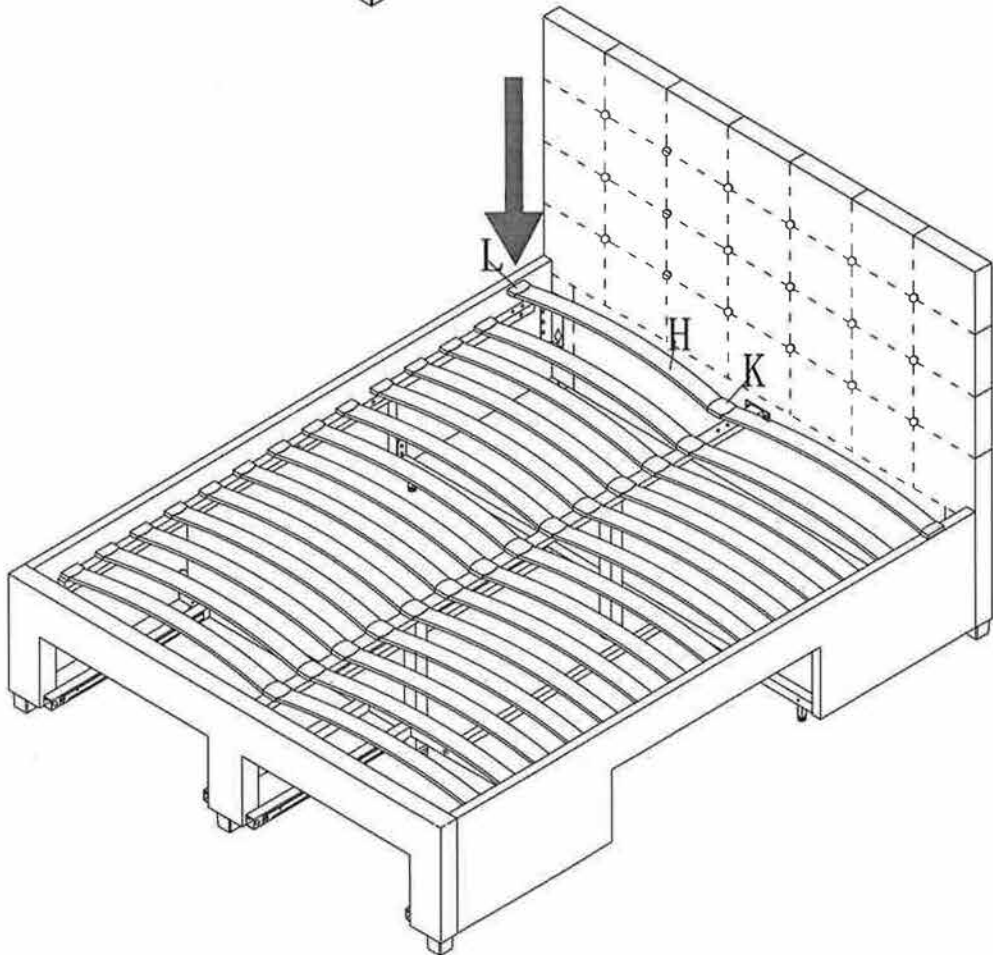
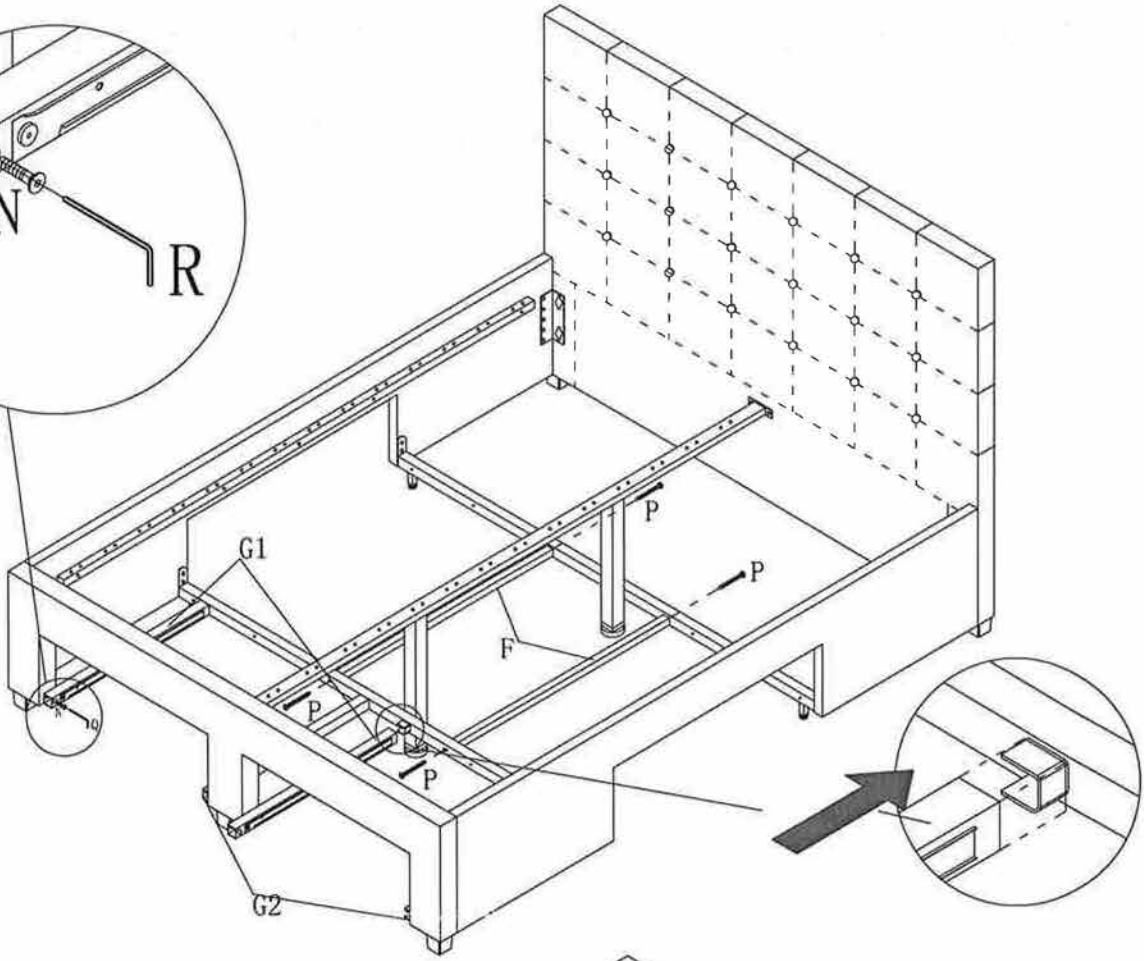
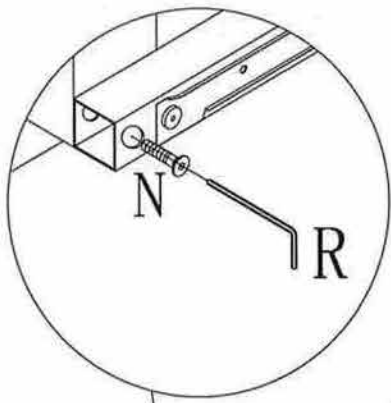

V  16pcs

Bolt M6x30

T  1pcs

Allen key M6

W  8pcs

screw 5 x 25mm

X  48pcs

Plastic plug

Y  48pcs

screw 5 x 50mm

Step:①

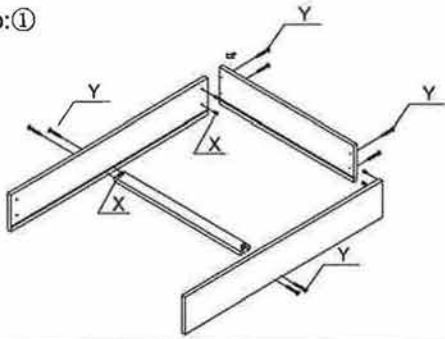

Step:②

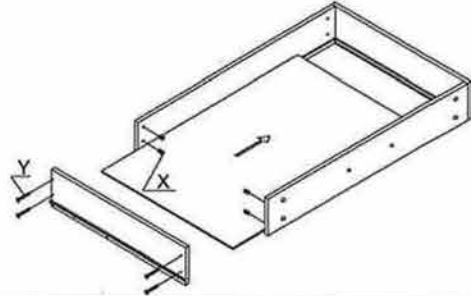

Step:③

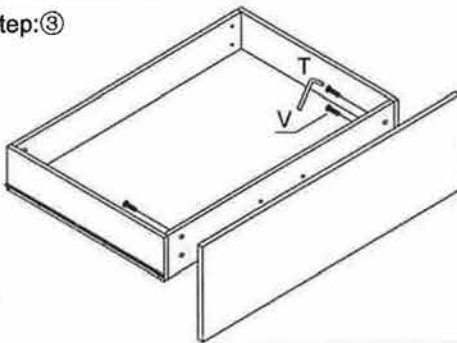

Step:④

