

T-2201-S

ASSEMBLY INSTRUCTIONS

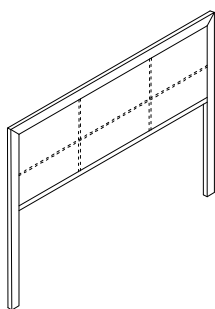

A*1PC

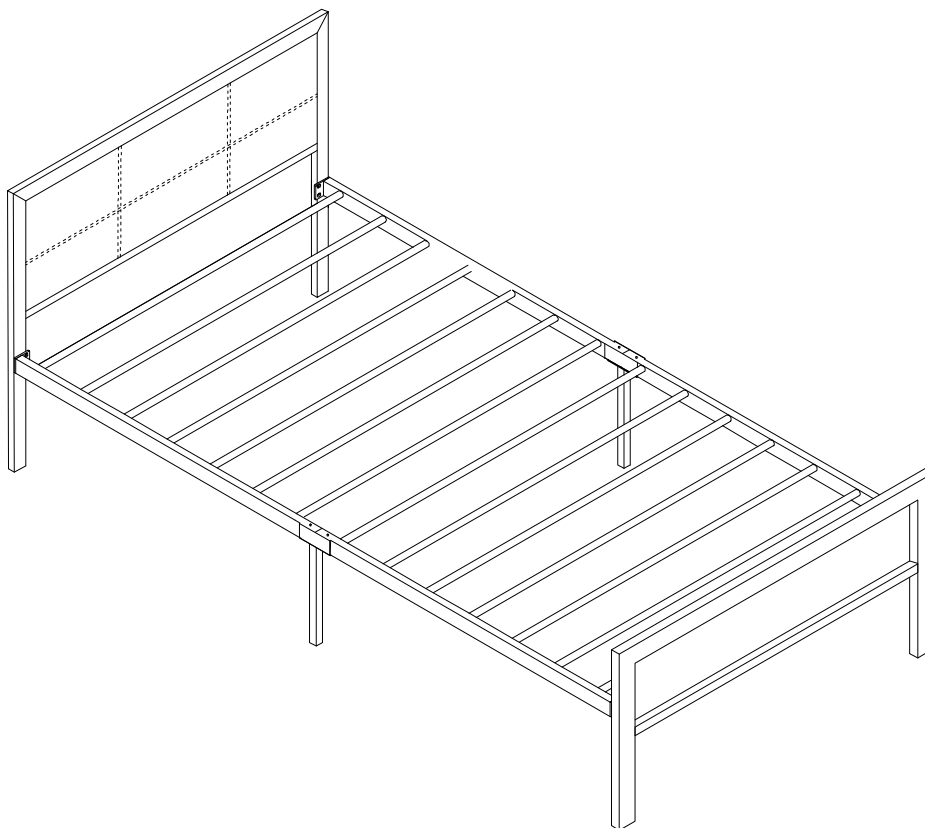
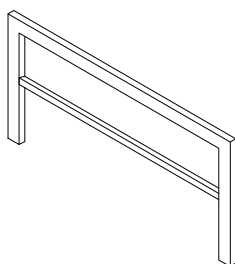

B*1PC

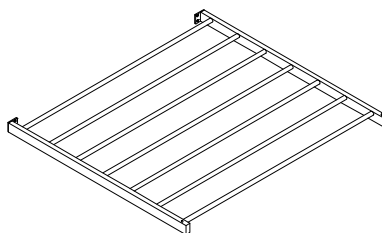

C*2PCS

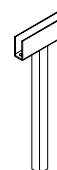

D*2PCS

E*8PCS



6. 35*16MM

F*4PCS

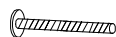

M8*50MM

G*4PCS



M8

H*1PC

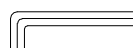

5M

I*1PC



4M

J*1PC



Note: Pls do not tighten all bolts until the bed is assembled completely

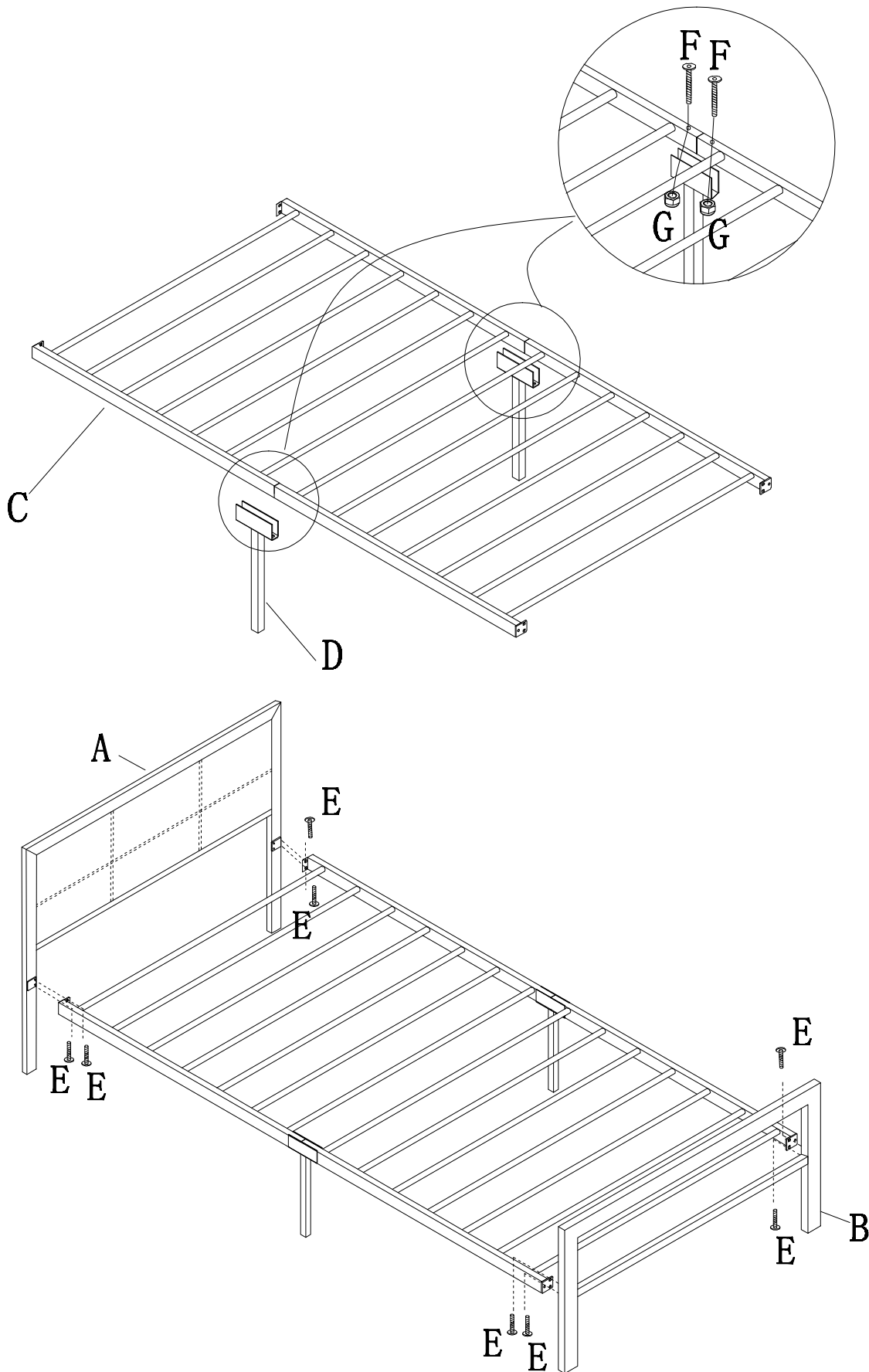

T-2201-D

ASSEMBLY INSTRUCTIONS

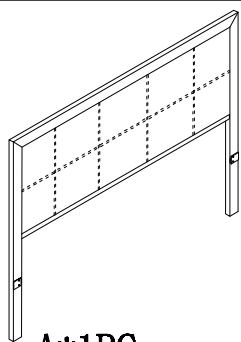
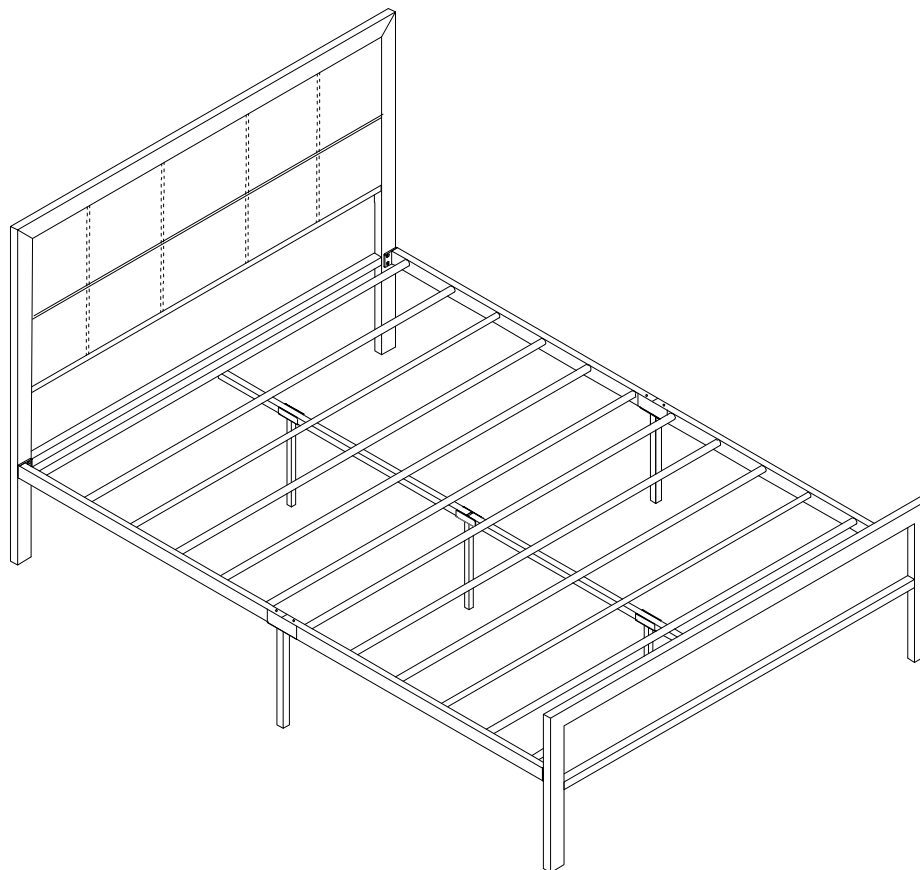

A*1PC

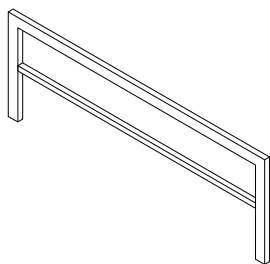

B*1PC

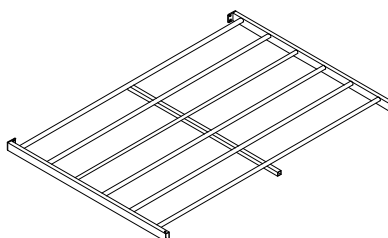

C*2PCS

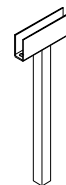

D*2PCS

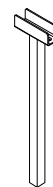

E*3PCS

F*8PCS



6. 35*16MM

G*4PCS



M8*50MM

H*6PCS



6. 35*25MM

I*4PCS



M8

J*1PC



5M

K*1PC



4M

L*1PC

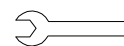

Note: Pls do not tighten all bolts until the bed is assembled completely

