



## 3036 DINING TABLE





ITEM: T - 3036  
DINING TABLE /  
TABLE SALLE A MANGER





### ASSEMBLY INSTRUCTIONS INSTRUCTIONS D'ASSEMBLAGE

Thank you for purchasing this product. Please take time to read and follow the instructions below. Check that you have all parts and hardware before assembly. Parts apparently missing are often found in the packing materials. If you do not have all the parts listed, have your dealer contact us and they will be sent to you immediately.

Merci d'avoir acheté ce produit de qualité. Veuillez lire et suivre instructions ci-dessous. Vérifiez avant le montage que vous avez toutes les pièces et fixations. Les pièces qui semblent manquer se trouvent souvent dans les matériaux d'emballage. Si vous n'avez pas toutes les pièces de la liste, demandez à votre détaillant et nous vous les enverrons immédiatement.

-  It is recommended to install protective pads under all legs and supports to avoid damage or scratches when placing furniture on a wood floor or other hard surface, and to limit indentation and prevent discoloration if placing on carpet.
-  Il est recommandé de placer des coussins protecteurs sous tous les pieds et toutes les bases des meubles pour éviter d'endommager ou d'égratigner les planchers en bois ou autres surfaces dures, et pour limiter l'empreinte et empêcher la décoloration quand les meubles reposent sur la moquette.

PARTS LIST / LISTE DE PIÈCES			
A		Table Top / Dessus de table	1
B		Table Leg / Patte de table	2
C		Mounting Plate / Plaque de montage	2
D		Cross Bar / Barre transversale	1
E		Stopper / Bouton en bois	2

HARDWARE LIST / LISTE DE QUINCAILLERIE			
1		JCBC Bolt / Boulon M6x40MM	20
2		JCBC Bolt / Boulon M6x70MM	4
3		Lock Washer / Rondelle d'arrêt M6x13MM	24
4		Allen Key / Clé Allen M4x65MM	1

### STEP 1 / ÉTAPE 1

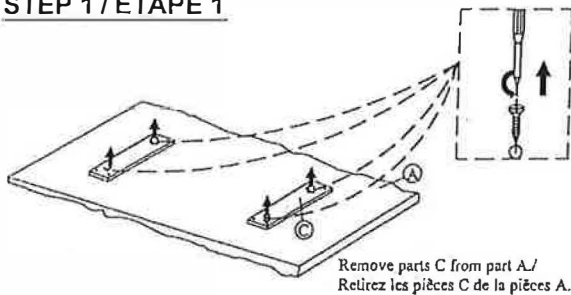

### STEP 2 / ÉTAPE 2

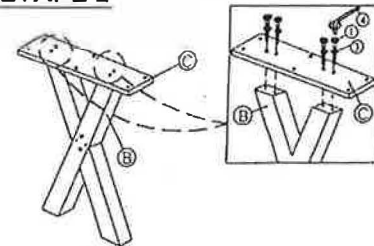

### STEP 4 / ÉTAPE 4

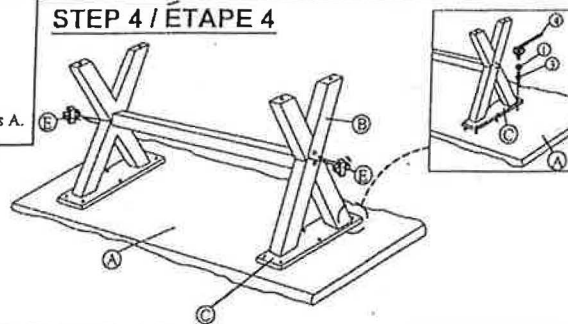

### STEP 3 / ÉTAPE 3

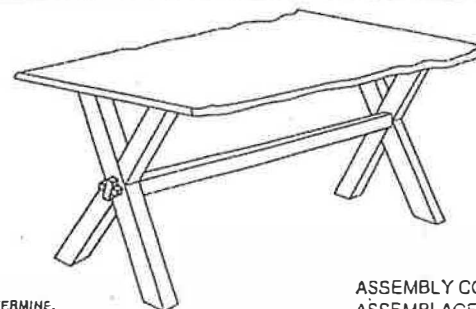
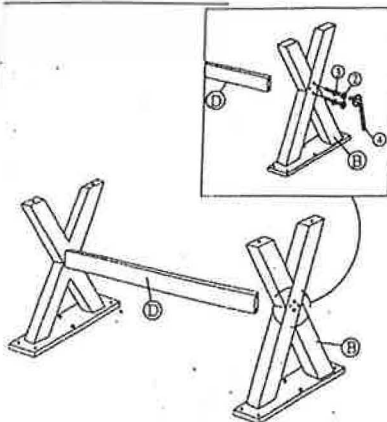

DO NOT TIGHTEN BOLTS UNTIL COMPLETELY ASSEMBLED.  
NE PAS SERRER LES BOULONS JUSQU'À CE QUE LE MONTAGE SOIT COMPLÈTMENT TERMINÉ.

ASSEMBLY COMPLETED /  
ASSEMBLAGE COMPLÈTE