

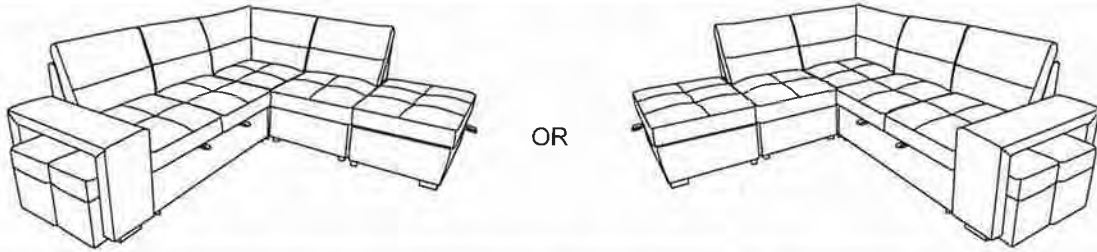

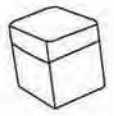

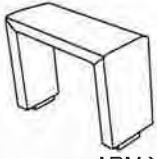

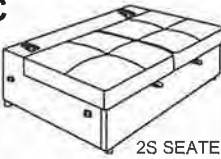





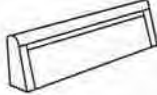

ASSEMBLY INSTRUCTION

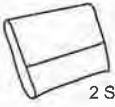
LFET-RIGHT REVERSIBLE

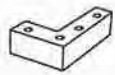

A  STOOLS X 2PCS	B  ARM X 1PC	C  2S SEATER FRAME X 1PC	D  CORNER SEATER FRAME X 1PC	E  ARMLESS CHAIR SEATER FRAME X 1PC
F  STORAGE OTTOMAN X 1PC	G  2S BACK FRAME X 1PC	H  CORNER BACK FRAME X 1PC	I  CORNER BACK FRAME X 1PC	J  ARMLESS CHAIR BACK FRAME X 1PC
K  2 SEATER ARMLESS CHAIR BACK CUSHION X 3PCS	L  CORNER BACK CUSHION X 1PC	M  CORNER BACK CUSHION X 1PC	N  CORNER SEATER ARMLESS CHAIR STORAGE OTTOMAN LEG X 10PCS	O  STORAGE OTTOMAN LEG X 2PCS
P  5 * 50MM LEG SCREWS X 18PCS	R  Bracket Cover X 2PCS			

Step 1:

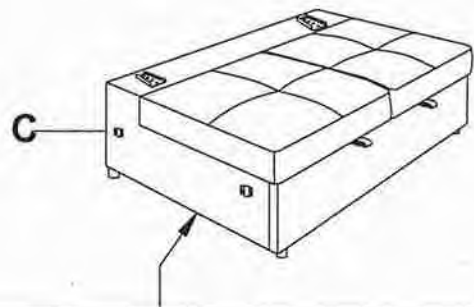

Find the "A/B/G/H" parts from 2 seater bottom

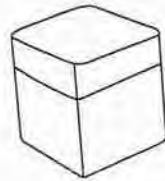
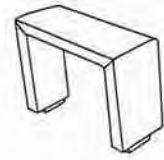
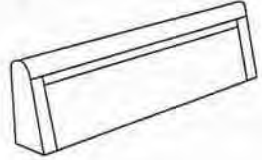
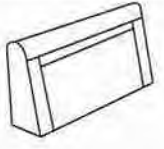
 A X 2PCS	 B X 1PC	 G X 1PC	 H X 1PC
---	--	---	--

Step 2:

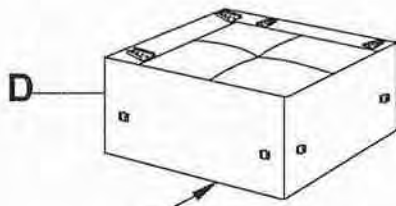

Open the corner seater bottom zipper
Find the "L/M/I" parts

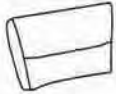

L X 1PC



M X 1PC



I X 1PC

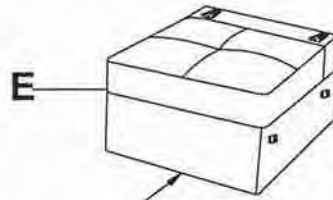

Open the armless chair seater bottom zipper, Find the hardware box of "N/O/P/R"
and parts "J/K" parts



J X 1PC



K X 1PC



N X 10PCS

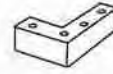

O X 2PCS



P X 18PCS



R X 2PCS

Step 3:

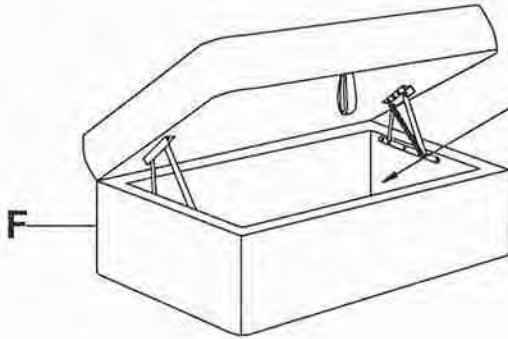

Find the parts "K" from ottoman's storage

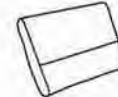

K X 2PCS

Step 4:

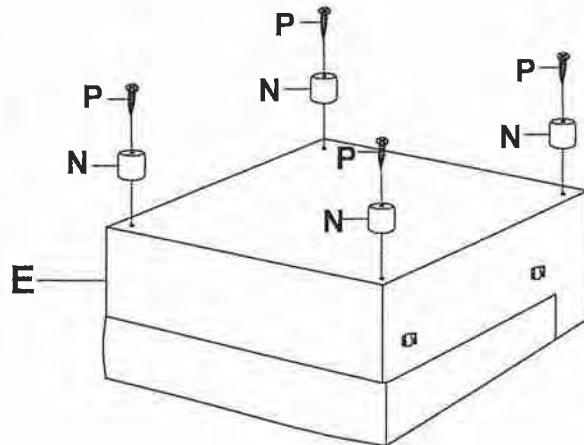
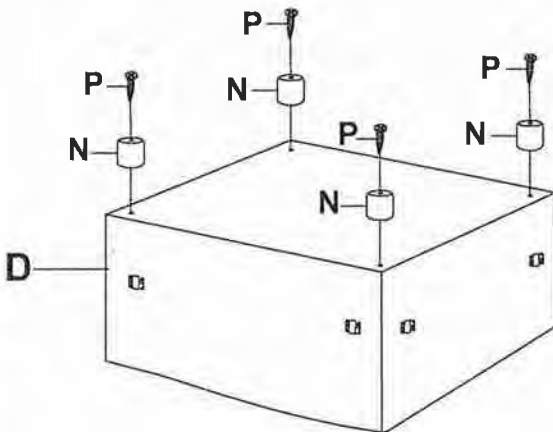

Step 5:

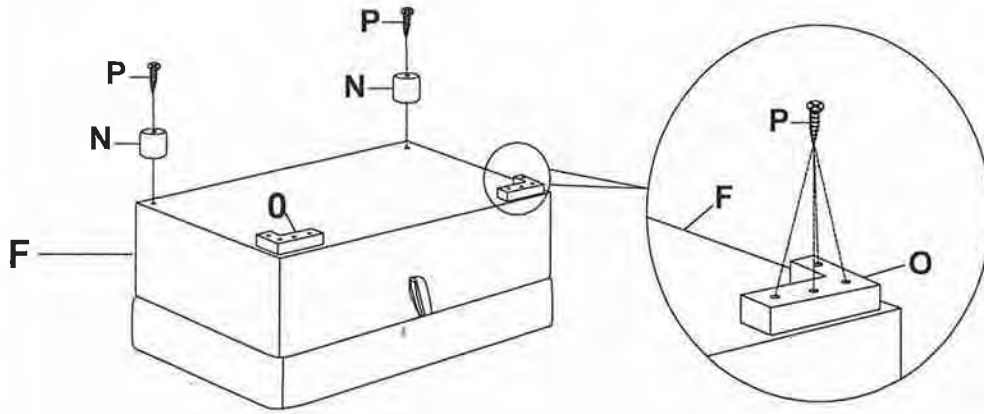

Step 6:

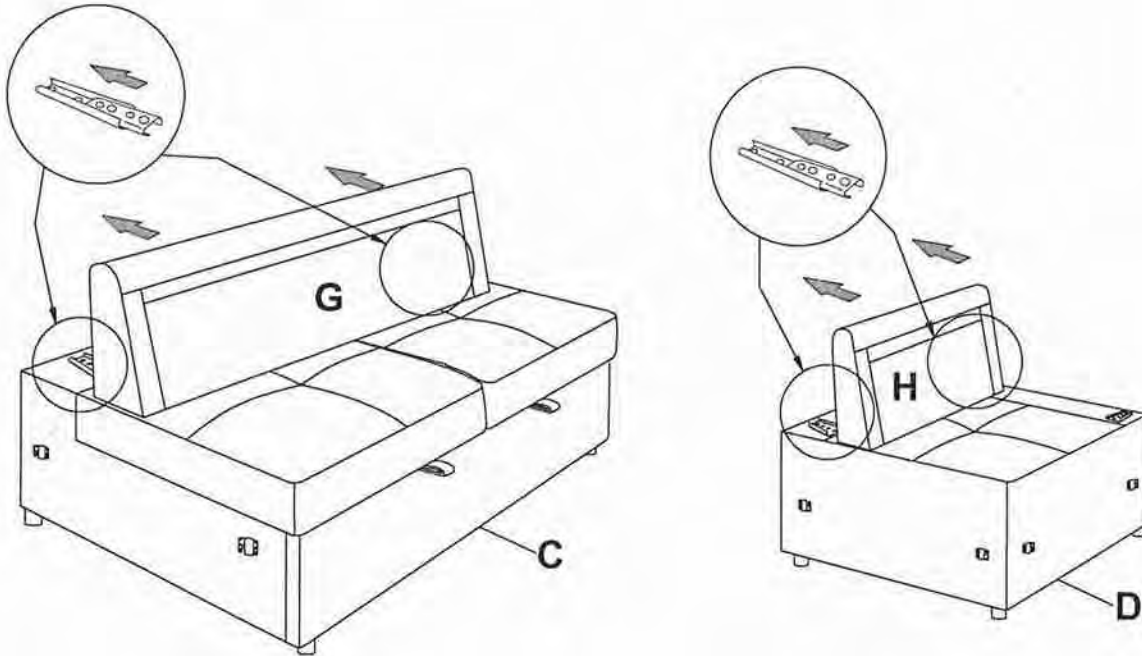

Step 7:

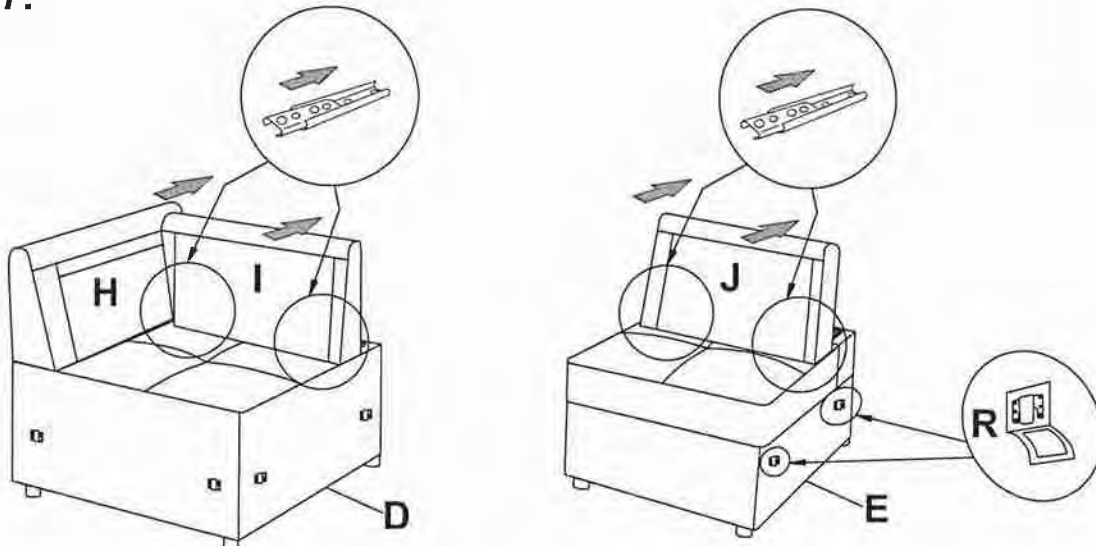

Step 8:

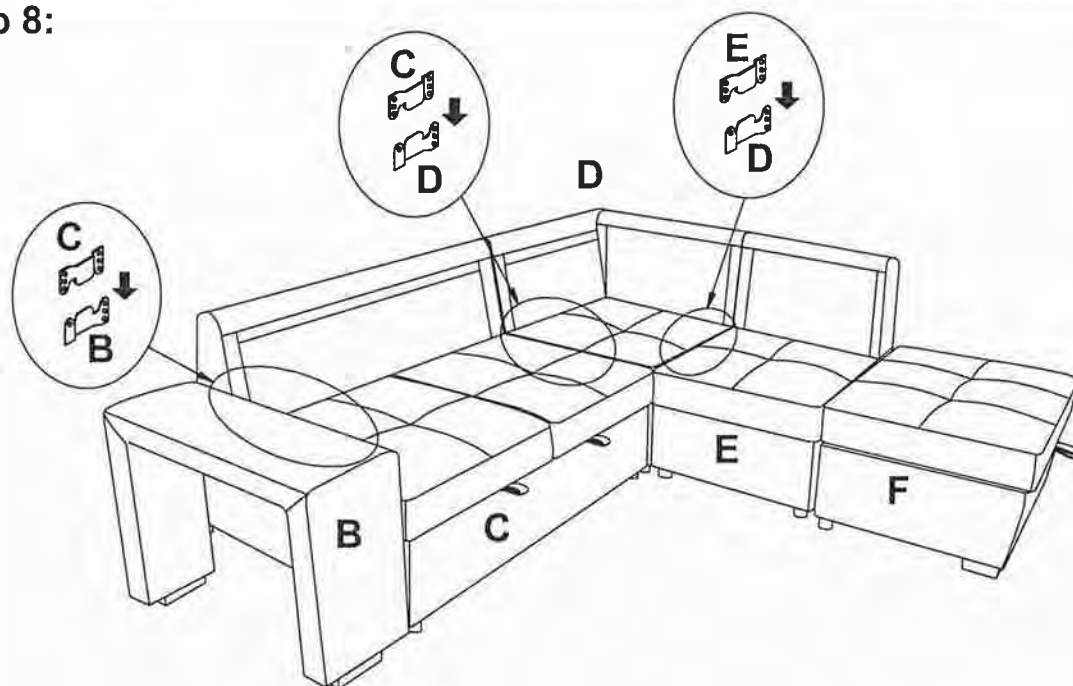

Step 9:

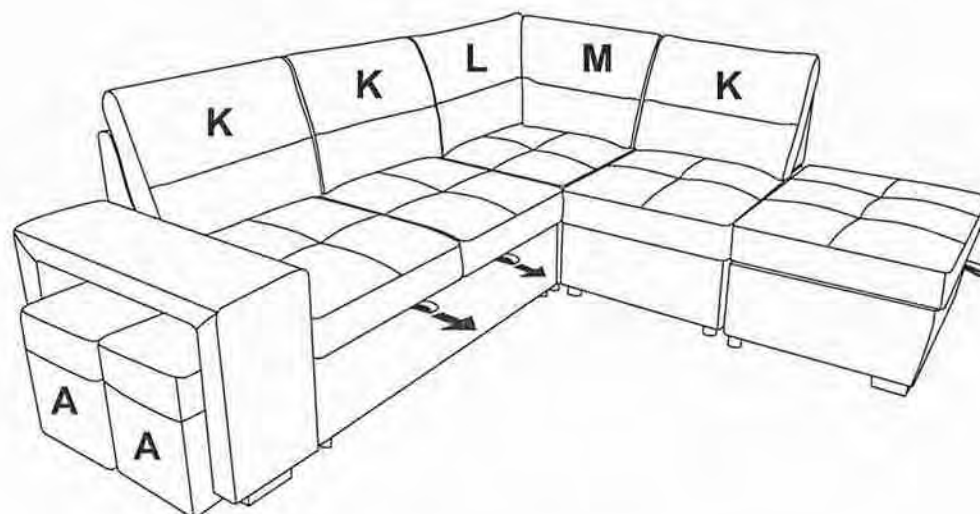

Step 10:

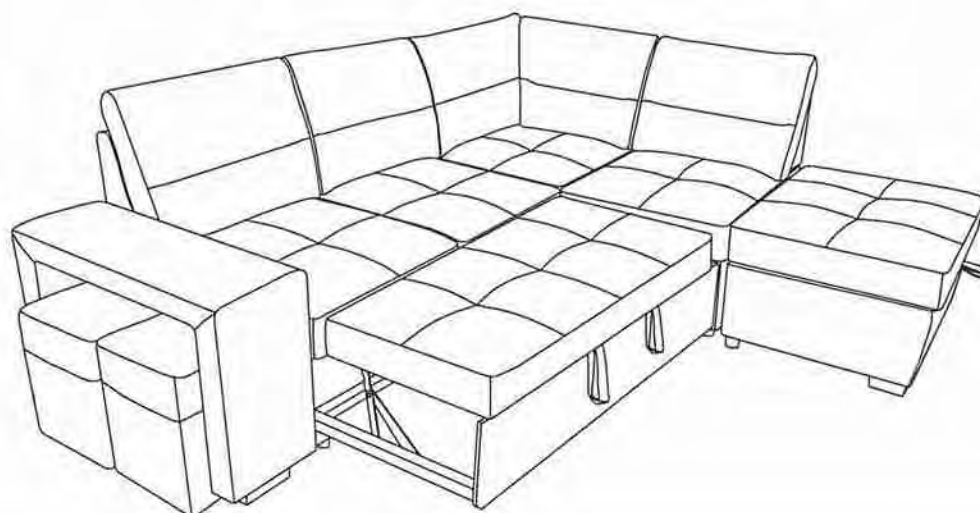

OR

